

**ENDGÜLTIG
FINAL**
10.12.2012

CODE: CEMENTOWNIA ODRA
PROJ.-NO.: 02-1/191.162/612

ISO 2768 mK EN ISO 13929-BF		150	
DETAILS PART 2/3 FLUIDCON CONVEYING		02-1/191.162-112/E-01	

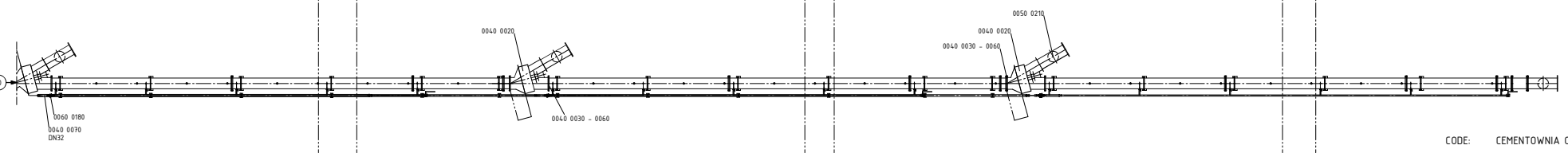
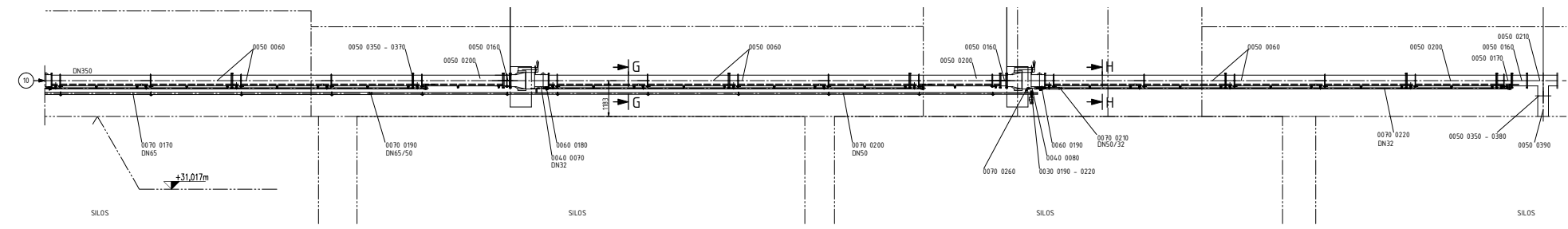
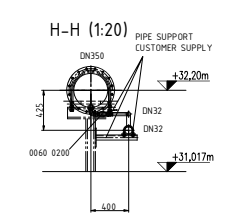
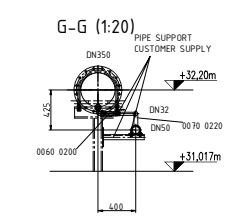
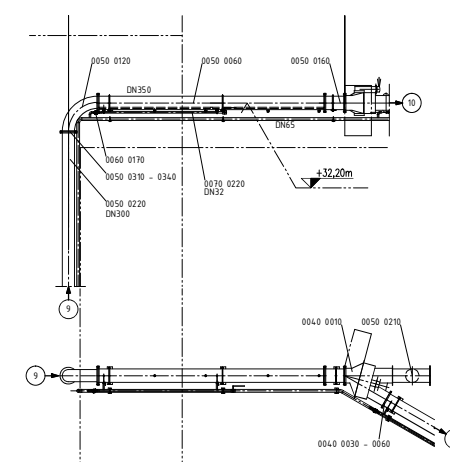
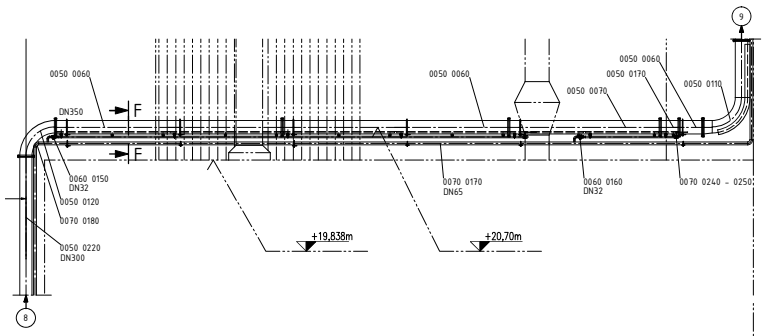
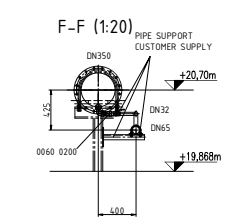
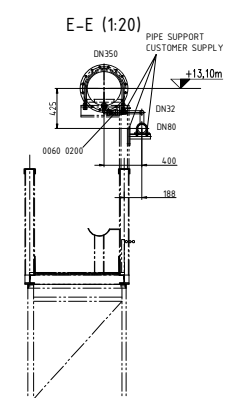
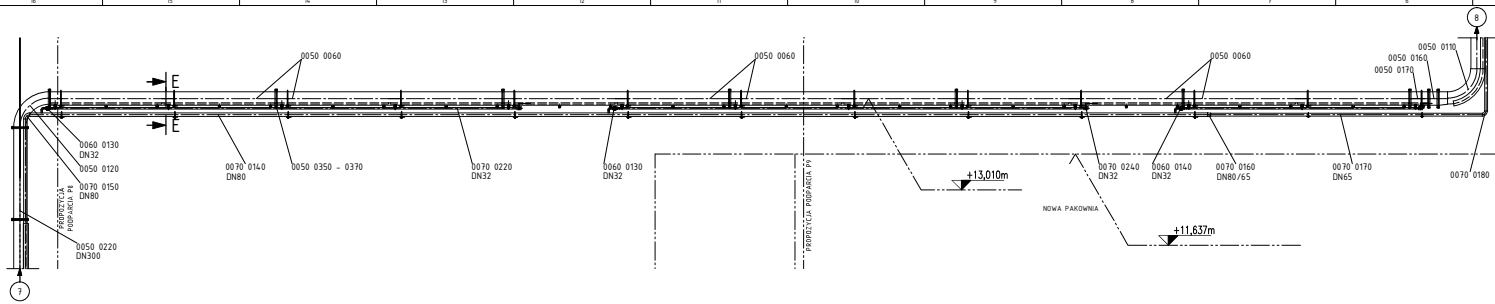

ZUR GENEHMIGUNG
FOR APPROVAL
5.12.2012

CODE: CEMENTOWNIA ODRA
PROJ.-NO.: 02-1/191.162/612

Drawing Scale: 1:50 Drawing Date: 5.12.2012 Drawing No.: 02-1/191.162/612		Drawing Title: CEMENTOWNIA ODRA Drawing No.: 02-1/191.162/612		Drawing Date: 5.12.2012 Drawing No.: 02-1/191.162/612	
Drawing Scale: 1:50 Drawing Date: 5.12.2012 Drawing No.: 02-1/191.162/612		Drawing Title: CEMENTOWNIA ODRA Drawing No.: 02-1/191.162/612		Drawing Date: 5.12.2012 Drawing No.: 02-1/191.162/612	
Drawing Scale: 1:50 Drawing Date: 5.12.2012 Drawing No.: 02-1/191.162/612		Drawing Title: CEMENTOWNIA ODRA Drawing No.: 02-1/191.162/612		Drawing Date: 5.12.2012 Drawing No.: 02-1/191.162/612	



DETAILS PART 3/3
FLUIDCON CONVEYING

02-1/191.162-113/E-00